

St. Vrain Door and Drawer

Table Of Contents

- 1) Outside Edge Profiles (E)
- 2) Frame Profiles (F)
- 3) Panel Profiles (RP/VP)
- 4) Square Top Design Series
- 5) Arch Top Design Series
- 6) Modified Top Design Series
- 7) Round Top Design Series
- 8) Crown Top Design Series
- 9) Applied Moulding Design Series
- 10) Slab Style Doors/Beaded Panel Designs
- 11) Glass Frame/Mullion Design Series
- 12) Lazy Susan Joinery information
- 13) Finger Pull Information



OUTSIDE EDGE PROFILES

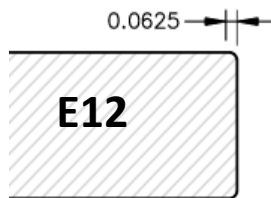
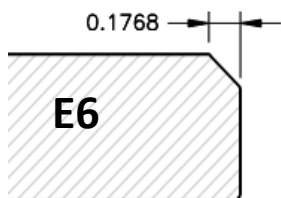
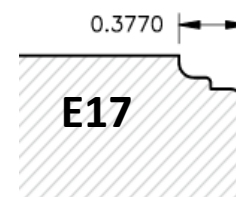
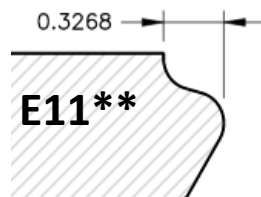
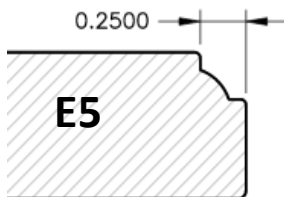
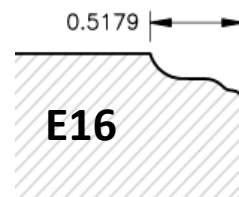
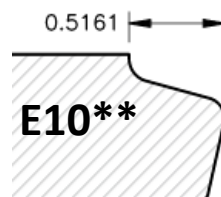
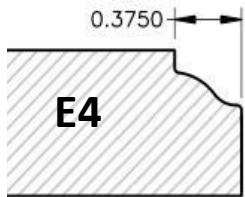
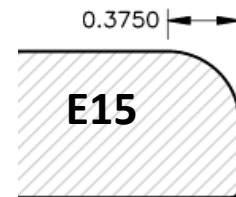
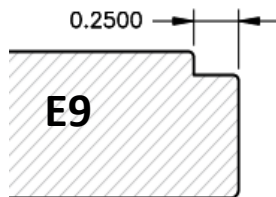
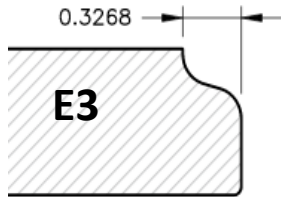
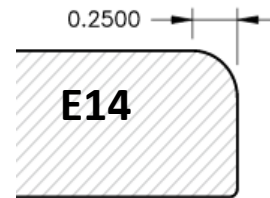
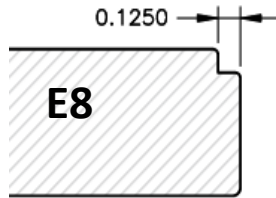
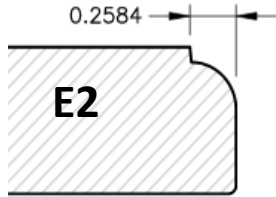
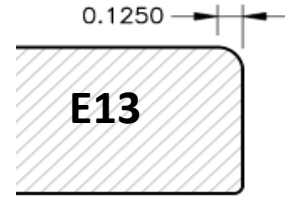
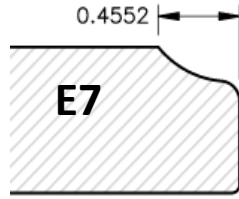

***E1 has an front side eased edge with the back having a .045" radius profile.**

**** E10 & E11, no cup hinge available due to back angled profile.**



FRAME PROFILES

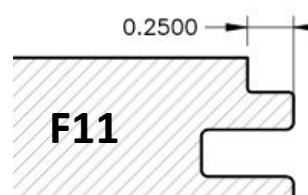
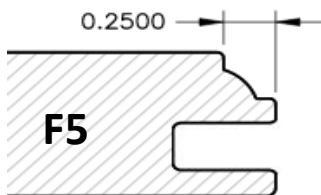
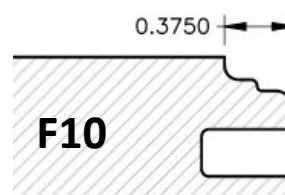
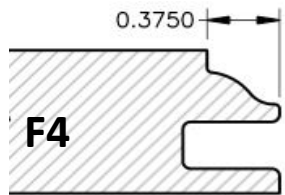
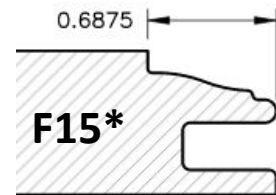
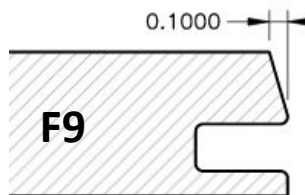
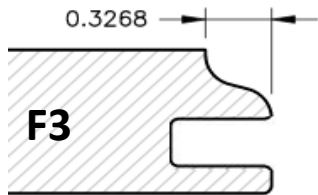
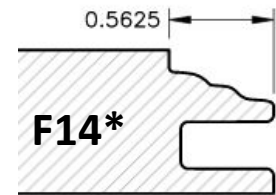
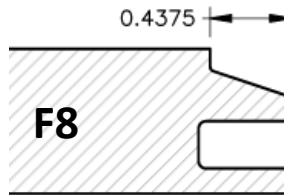
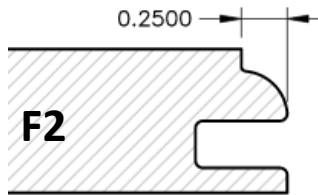
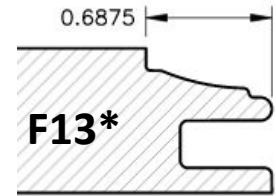
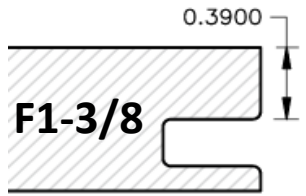
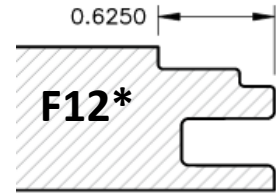
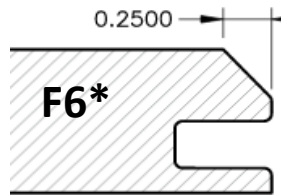
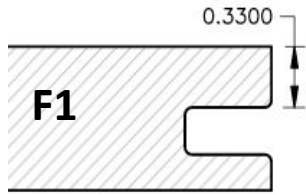

* Additional \$.075 per sq. ft. required.



PANEL PROFILES (All RP profiles have back cut profile)



1/4" Veneer face w/ MDF core

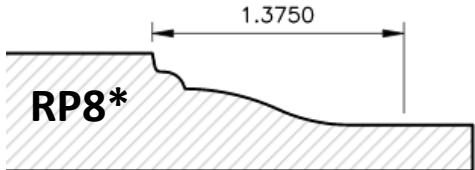
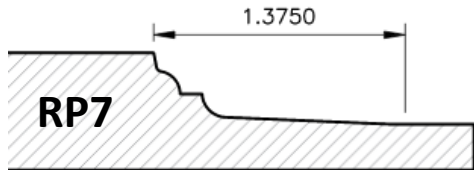
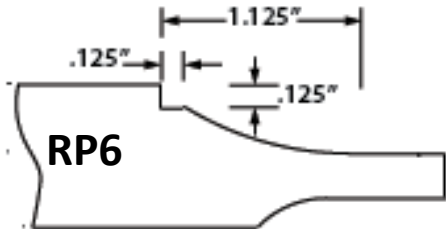
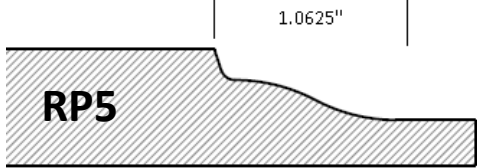
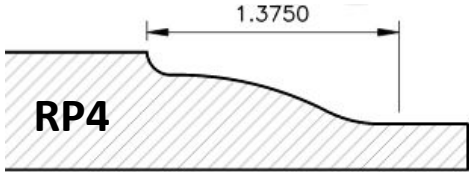
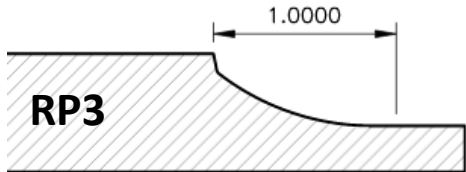
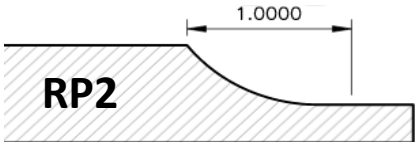
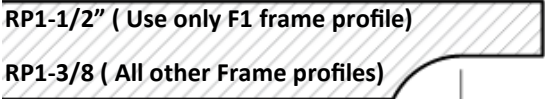

* Additional \$.50 per sq/ft

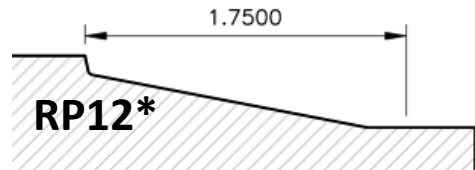
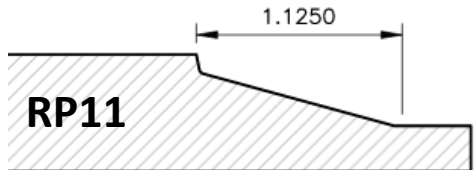
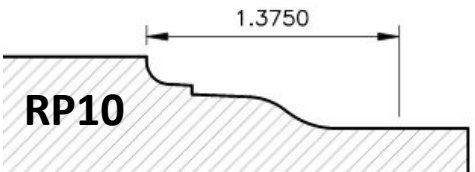
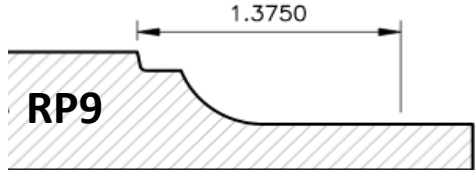

* Additional \$.50 per sq/ft

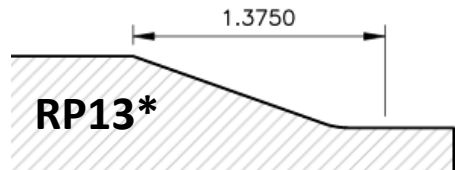

* Additional \$.50 per sq/ft

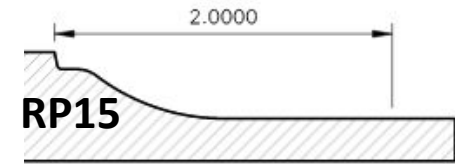
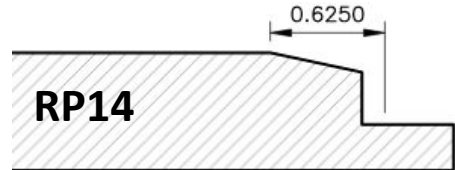

Square Top Design Series

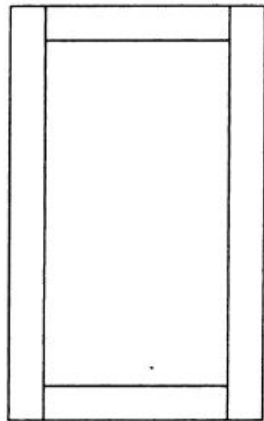

VP 1000

**Square Top Flat Panel
1/4" Veneered Panel**

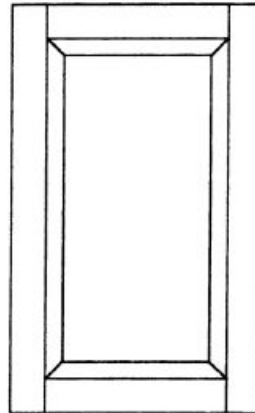

RP 1000

**Square Top
Raised Panel**

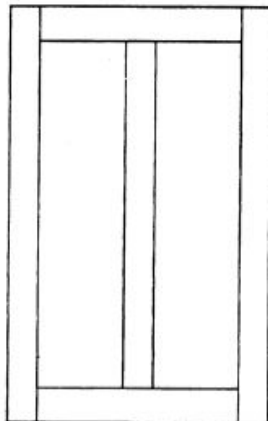

VP 1002

**Square Top 2 panel Vertical equal
Flat Panel
1/4" Veneered Panel**

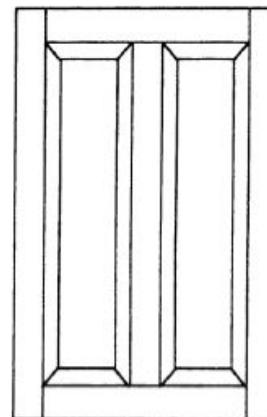

RP 1002

**Square Top 2 panel Vertical equal
Raised Panel**

Center Rail Specifications

Door heights over 48" require a center rail placed standard on center, to be covered under warranty. For offset center placement provide dimensions layout.

Glass Doors

Frame only doors with rubber panel retainer also available.

Solid Wood Flat Panel

RP stile door with RP 1-1/2 panel profile with E1 inside edge profile. This will be a 1/4" recessed from face to door.

All other E profiles require the RP 1-3/8 panel profile and will be recessed from door face 3/8".



Arch Top Design Series



VP 1300

**Arch Top Flat Panel
1/4" Veneered Panel**

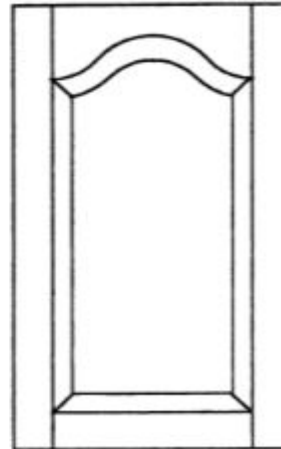

RP 1300

**Arch Top
Raised Panel**

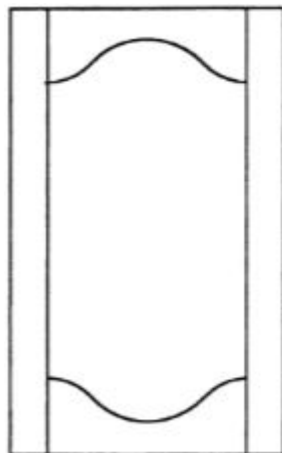

VP 1302

**Double Arch (Top/Bottom)
Flat Panel
1/4" Veneered Panel**

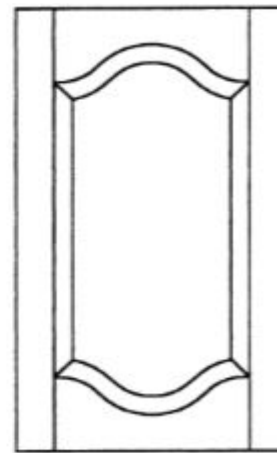

RP 1302

**Double Arch (Top/Bottom)
Raised Panel**

Center Rail Specifications

Door heights over 48" require a center rail placed standard on center, to be covered under warranty. For offset center placement provide dimensions layout.

Glass Doors

Frame only doors with rubber panel retainer also available.

Solid Wood Flat Panel

RP stile door with RP 1-1/2 panel profile with E1 inside edge profile. This will be a 1/4" recessed from face to door.

All other E profiles require the RP 1-3/8 panel profile and will be recessed from door face 3/8".



Modified Top Design Series

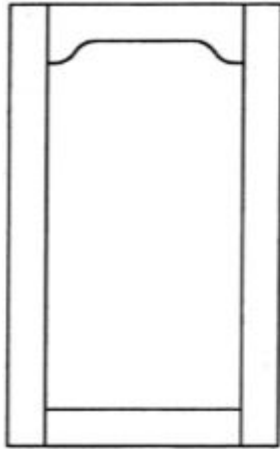

VP 1400

**Modified Top Flat Panel
1/4" Veneered Panel**

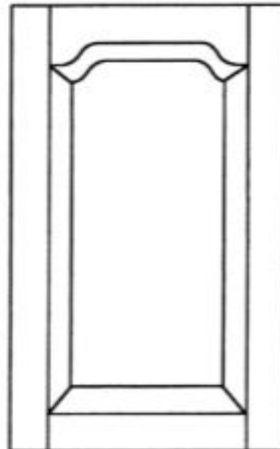

RP 1400

**Modified Top
Raised Panel**

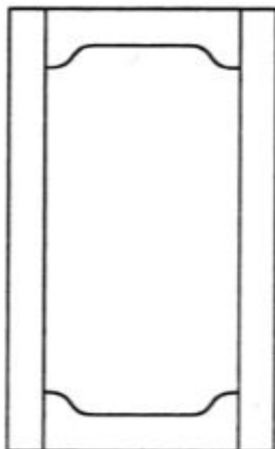

VP 1402

**Double Modified (Top/Bottom)
Flat Panel
1/4" Veneered Panel**

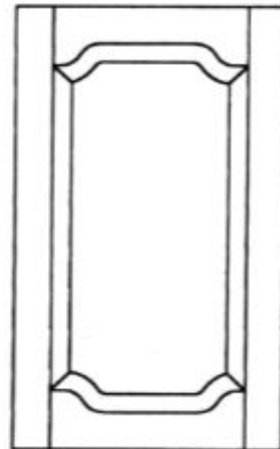

RP 1402

**Double modified (Top/Bottom)
Raised Panel**

Center Rail Specifications

Door heights over 48" require a center rail placed standard on center, to be covered under warranty. For offset center placement provide dimensions layout.

Glass Doors

Frame only doors with rubber panel retainer also available.

Solid Wood Flat Panel

RP stile door with RP 1-1/2 panel profile with E1 inside edge profile. This will be a 1/4" recessed from face to door.

All other E profiles require the RP 1-3/8 panel profile and will be recessed from door face 3/8".



Round Top Design Series

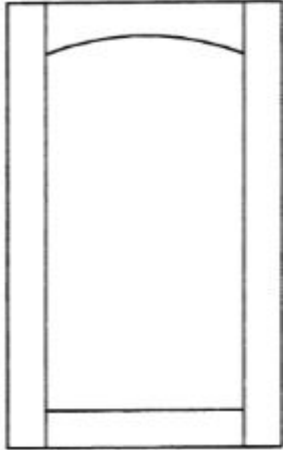

VP 1100

**Round Top Flat Panel
1/4" Veneered Panel**

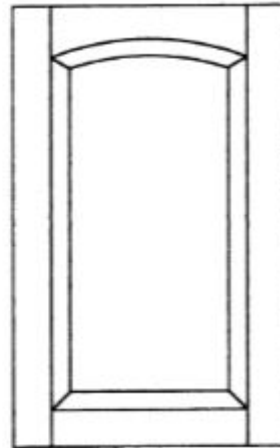

RP 1100

**Round Top
Raised Panel**

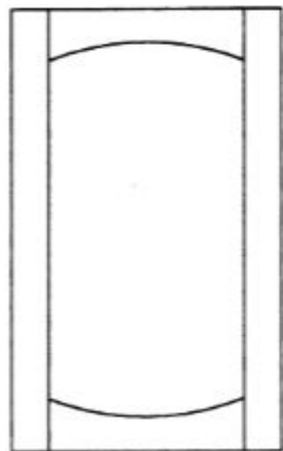

VP 1102

**Double Round (Top/Bottom)
Flat Panel
1/4" Veneered Panel**

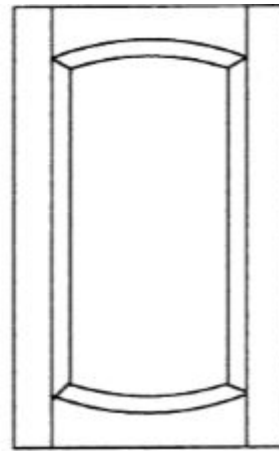

RP 1102

**Double Round (Top/Bottom)
Raised Panel**

Center Rail Specifications

Door heights over 48" require a center rail placed standard on center, to be covered under warranty. For offset center placement provide dimensions layout

Glass Doors

Frame only doors with rubber panel retainer also available.

Solid Wood Flat Panel

RP stile door with RP 1-1/2 panel profile with E1 inside edge profile. This will be a 1/4" recessed from face to door.

All other E profiles require the RP 1-3/8 panel profile and will be recessed from door face 3/8".



Crown Top Design Series

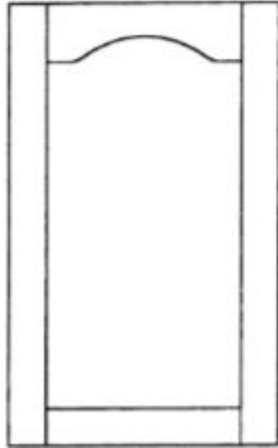

VP 1200

**Crown Top Flat Panel
1/4" Veneered Panel**

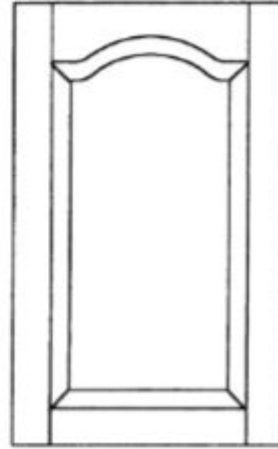

RP 1200

**Crown Top
Raised Panel**

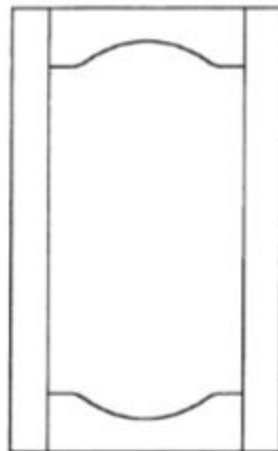

VP 1202

**Double Crown (Top/Bottom)
Flat Panel
1/4" Veneered Panel**

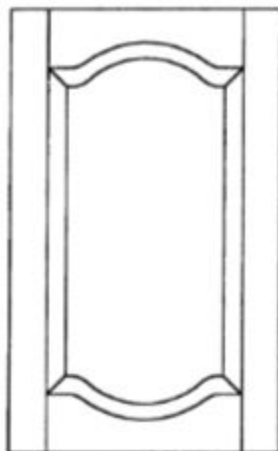

RP 1202

**Double Crown (Top/Bottom)
Raised Panel**

Center Rail Specifications

Door heights over 48" require a center rail placed standard on center, to be covered under warranty. For offset center placement provide dimensions Layout

Glass Doors

Frame only doors with rubber panel retainer also available

Solid Wood Flat Panel

RP stile door with RP 1-1/2 panel profile with E1 inside edge profile. This will be a 1/4" recessed from face to door.

All other E profiles require the RP 1-3/8 panel profile and will be recessed from door face 3/8"



Applied Moulding Design Series

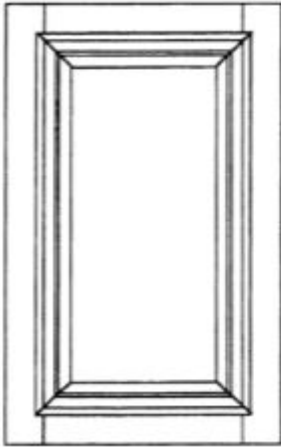

VP1000 VP1002

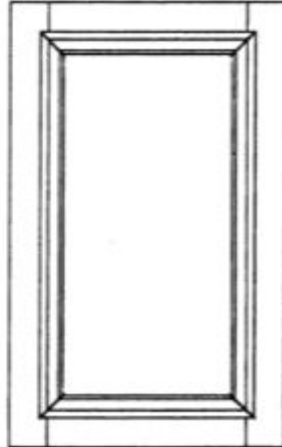

RP1000 RP1002

Applied Moulding Design

Mouldings are dimensional for a 3/8" inside edge, and are only available in square top designs. F1-3/8 profile only for inside edge.

Moulding is micro pinned and Glued to frame only.

AP= Choose Series 1000 and then make a choice in the Applied Moulding Profile choices.

Standard Applied Moulding Designs

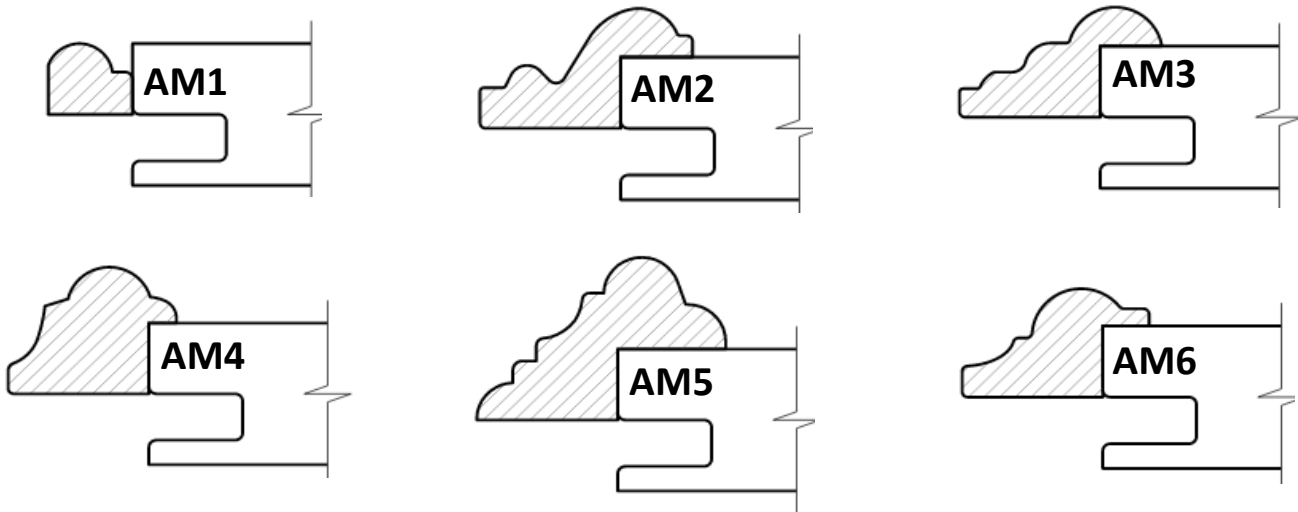

Center Rail Specifications

Door heights over 48" require a center rail placed standard on center, to be covered under warranty. For offset center placement provide dimensions Layout.

Glass Doors

Frame only doors with rubber panel retainer also available.

Reversed Raised Panel With Applied Moulding

Reversed raised panel will be 3/8" thick (RP1-3/8 panel profile).



Slab Style Doors

Slab Style Doors
SL101 SL100

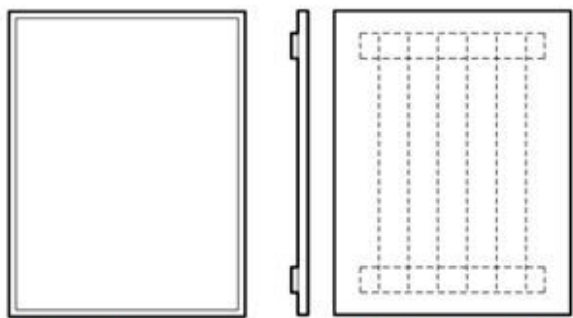

NO Batten With batten and kerf pattern.

Warranty Note:
Solid slab doors have a potential to warp, twist and cup. St. Vrain Door and Drawer warranty will only cover slab style SL100 only. SL100 includes saw kerfs cut into half of thickness of the slab on the back face, 2 1/4" on center and 2 1/4" from each end. The kerf ends are covered with 1/2" x 2 1/4" battens. Battens are screwed 2 inches away from slab edges.

Beaded Panel Design Series

BEADED PANEL PROFILES

Spacing on inch centers as follows: 1, 1.25, 1.5, 1.75, 2, 2.25, 2.5, 2.75, 3, 3.25, 3.5, 3.75, 4. Custom centers on request.

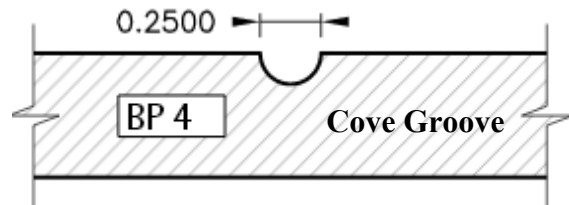
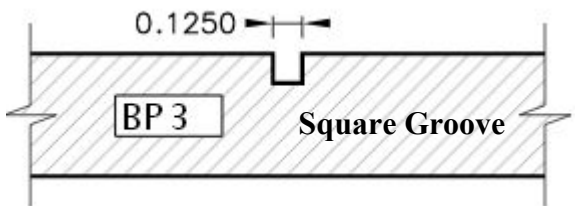
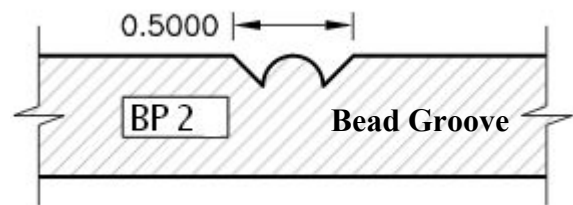
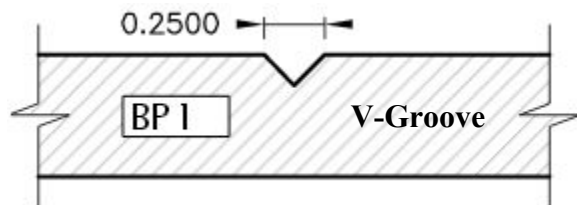

Glass Frame Design Series

GLASS FRAME PROFILES



Clear flexible glass retainer moulding to hold 1/8" glass thickness is provided with the Retainer Profile.

Mullion/French Lite Design Series

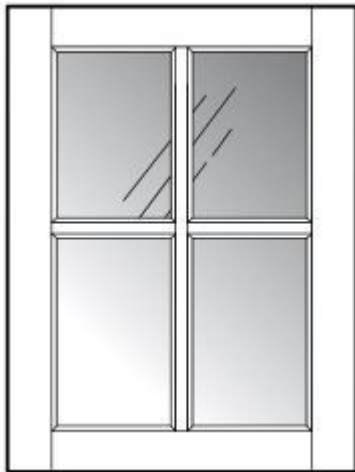

4 French Lite

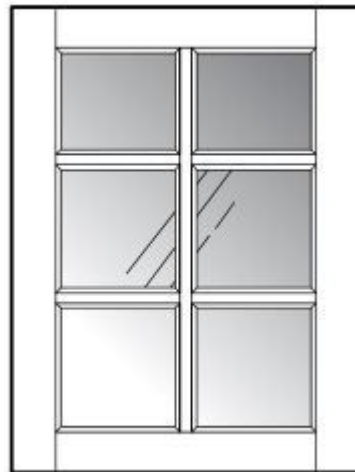

6 French Lite

*Standard design is with all lites being of equal size.

*All frame "F" profiles are available as glass mullion stock.



Lazy Susan Joinery

Lazy Suzan Butt Joint information

Code:	Description:
LZS-BJ-LA	Butt joint doors, Left stile with added 3/4" width.
LZS-BJ-RA	Butt joint doors, Right stile with added 3/4" width. Choose Option above for door with extended stile width. Customer to provide dimension including the additional 3/4"
	Allows you to assemble to other door with fasteners of your choice or hinge. Additional charge applies. \$3.00 each door
LZS-BJ-LS	Standard size door with butt edge that attaches to other door, left stile.
LZS-BJ-RS	Standard size door with butt edge that attaches to other door, right stile. Choose Option above for standard door dimension. This option will apply a butt edge to the stile that attaches to the other door. Additional charge applies. \$3.00 each door

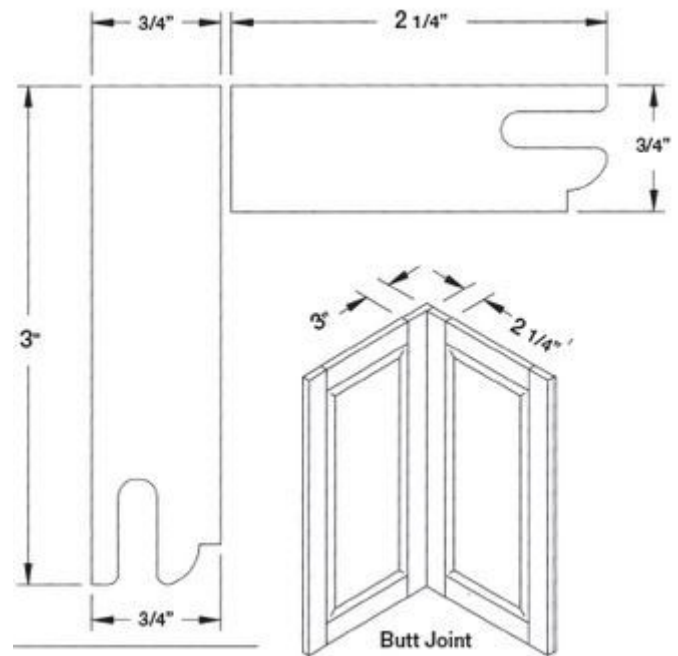

*Each Lazy Susan order with butt joint construction must have a door labeled with (LA/RA) and a door labeled (LS/RS).

Lazy Suzan 45 Degree Miter Joint Information

Code:	Description:
LZS-MJ-L	45dg Miter joint, Left stile with added 3/4" width.
LZS-MJ-R	45dg Miter joint, Right stile with added 3/4" width. Customer to provide dimension including 3/4" stile width extension for miter joint. Assembly by customer. Additional charge applies. \$15.00 each door

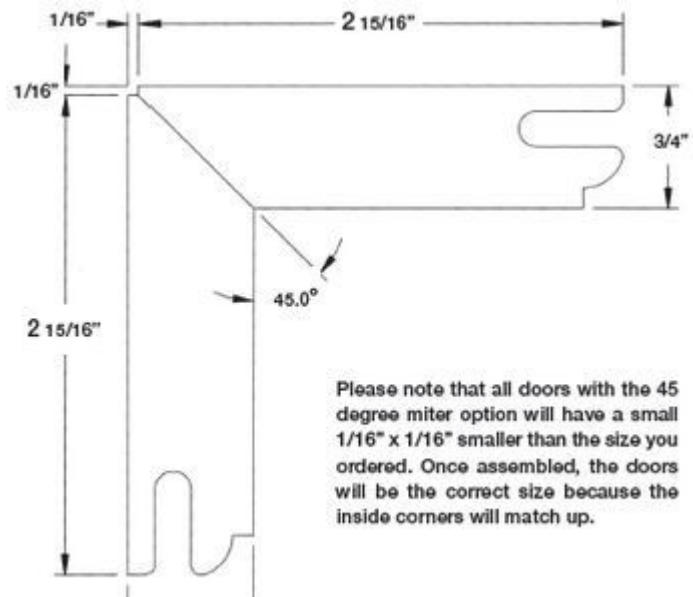
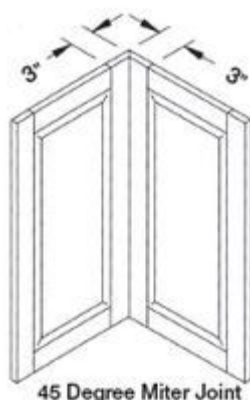

Finger Pull Information

General Notes:

- 1) Position is viewed from the front of the door or drawer front.
- 2) All finger pulls are routed on the back side of the door or drawer front.
- 3) Bore size height 3/8" depth will vary depending on outside edge profile (1/4"-3/8").

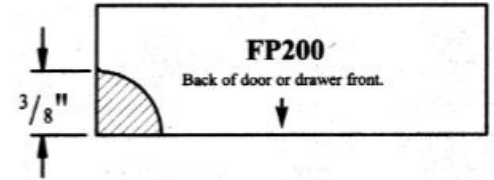

\$6.00 per finder pull — Full width finger pull and position:

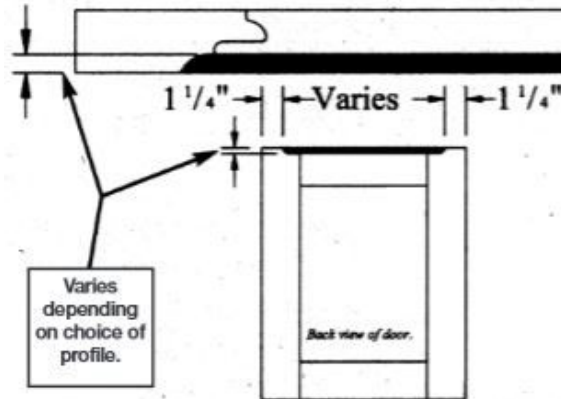

Code#	\$ Per	Position (as viewed from frontside)
T	\$6.00	Top rail, full length
B	\$6.00	Bottom rail, full length
R	\$6.00	Right rail, full length
L	\$6.00	Left rail, full length

Example of T position

\$4.00 per finder pull — 4" wide finger pull and position:

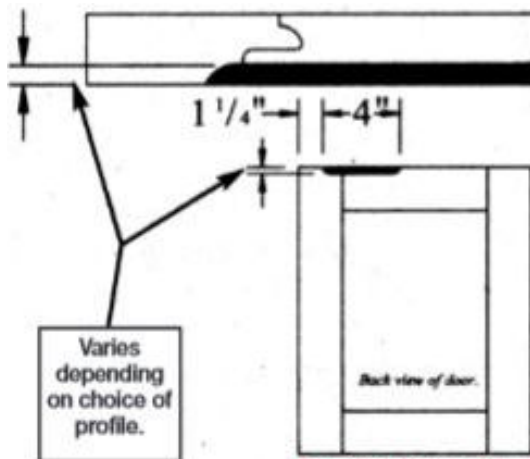

Code#	\$/per	Position (As viewed from front side)
TRR	\$ 3.00	Top rail, right position
TRC	\$ 3.00	Top rail, center position
TRL	\$ 3.00	Top rail, left position
BRR	\$ 3.00	Bottom rail, right position
BRC	\$ 3.00	Bottom rail, center position
BRL	\$ 3.00	Bottom rail, left position
RST	\$ 3.00	Right stile top position
RSC	\$ 3.00	Right stile center position
RSB	\$ 3.00	Right stile bottom position
LST	\$ 3.00	Left stile top position
LSC	\$ 3.00	Left stile center position
LSB	\$ 3.00	Left stile bottom position

Example of TRL position

*Minimum width for top or bottom positions is 6 1/2"

*Minimum height for side position is also 6 1/2"

